



# Ronda

---

Acoustic lamp

 **NOVERB**  
DESIGN

[www.noverb-design.com](http://www.noverb-design.com)

## General

**Dimension:** 42 x 39 cm

**Weight:** 4 kg\*

**Input voltage:** 120-230v

**Input frequency:** 50/60 Hz

**Wattage:** max. 60 watt

**Cable:** 2 mt white fabric cable\*\*

**Materials:** Acoustic Foam UL94-HF1, birch plywood phenolic with transparent finish\*\*\*

**Fixing system:** White round metal ceiling canopy, diameter 12 cm (conical plastic cable clamp)

**Light point:** E27 white metal lamp holder

**Certifications:**  listed |  PATENTED product

\* Verify load capacity of the ceiling prior to installation.

\*\* Different colors and lengths on request.

\*\*\* Different finishes on request.

## Acoustics

The graph refers to the absorption of a single lamp in an environment of 2 square meters.

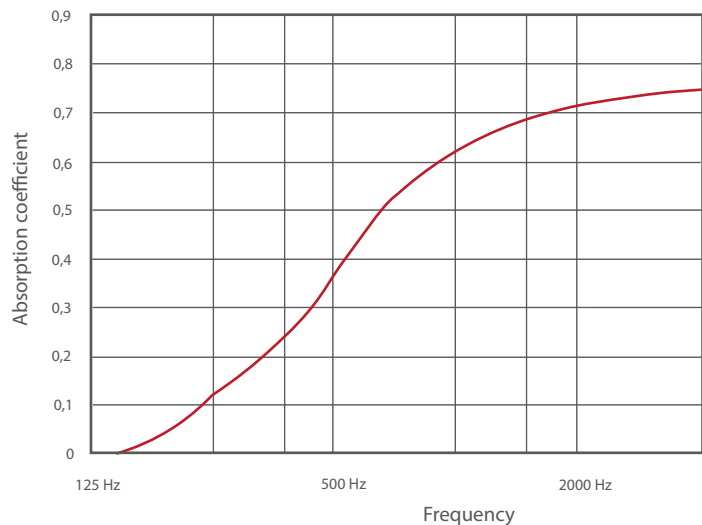

## Sound absorbing material

**Material:** PU Polyether T25 AUX, painted with low Cov content water paint.

**Amount:** 0,4 mq

**Number of slats:** 12, tickness 4 cm

**Slats hooking:** Velcro grip

**Density:** ISO 845 25 Kg/m<sup>3</sup>

**Flame test according to standard:** UL94-HF1

**Temperature Range:** -20°C / +110°C

## Configuration

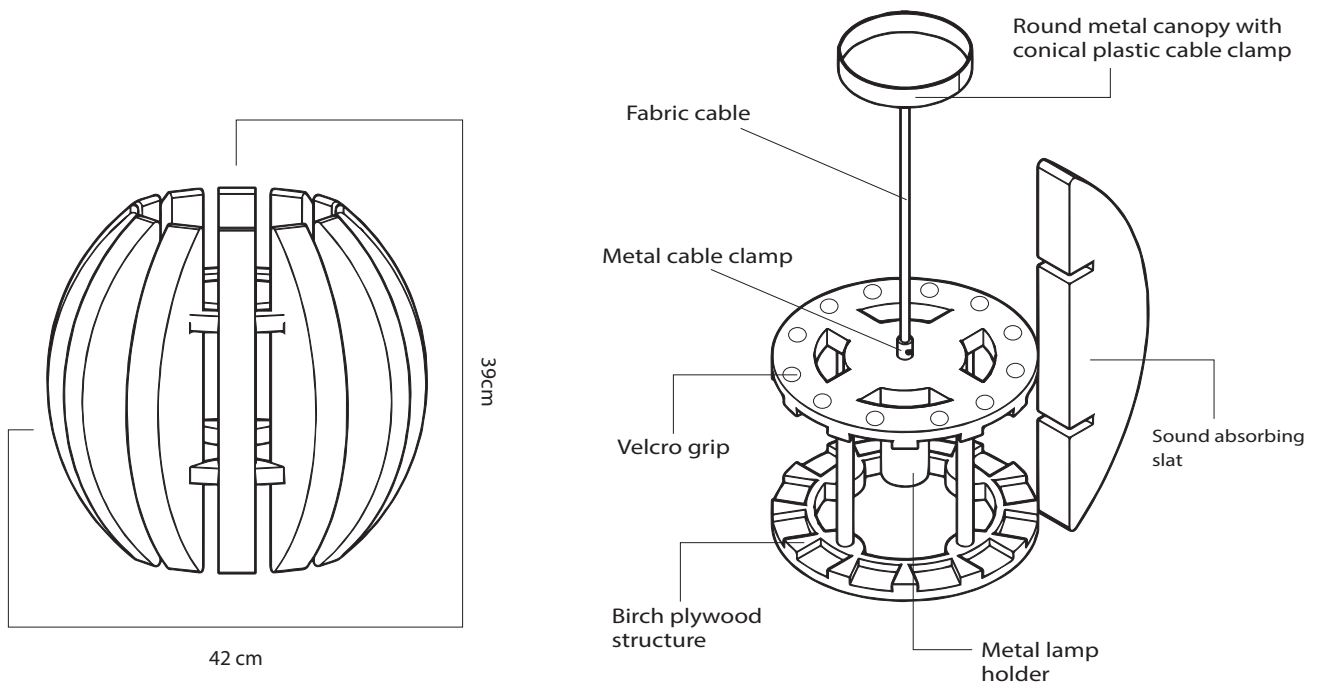

## Photometric data

**Led bulb reference:** 17.5 W, 3000K, 180°,  
2500 lumen

**Direct light angle:** 86°

**Diffused light angle:** 180° as well as reference  
led bulb (through the slats).

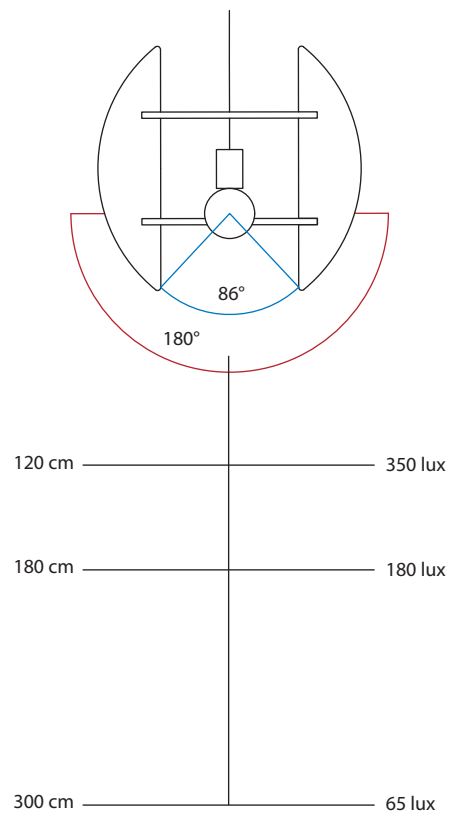

## Assembly instructions

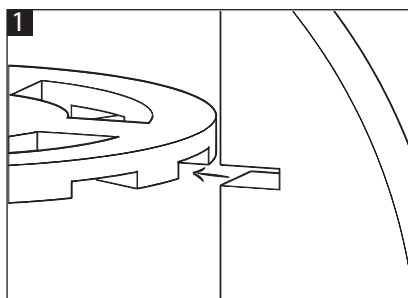

1 Bring the slat closer to the structure making the joints coincide.

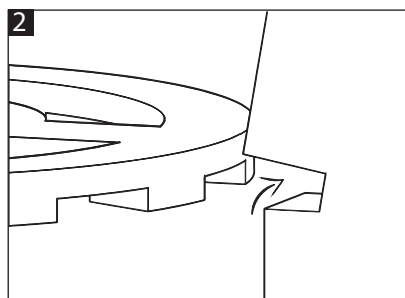

2 Slightly raise the tips of the slat to facilitate insertion.

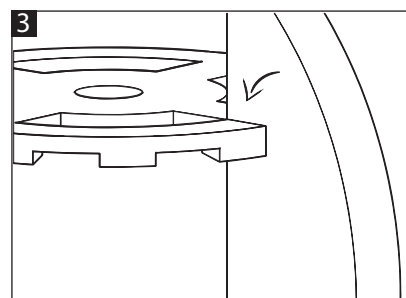

3 Release the tips of the slat and make it stick to the velcro.

## Foam colors

Dark green



Light green



Green water



Blue



Red brick



Ocher



Bordeaux

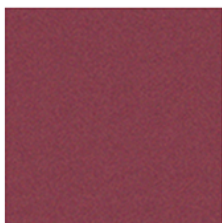

Anthracite



Grey



Off white

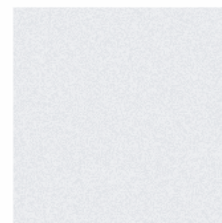

\*Different colors on request.