

ISTRUZIONI DI MONTAGGIO

ASSEMBLY INSTRUCTIONS

- 1) rimuovere la base  
1) remove the base

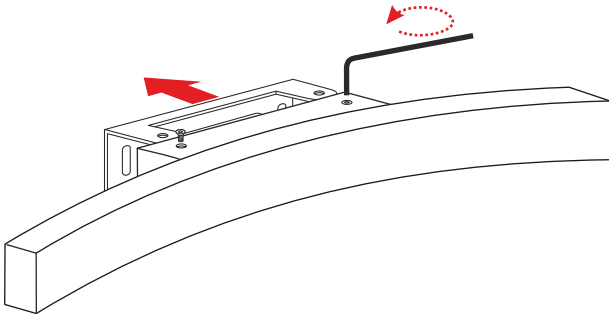

- 2) fissare la base alla parete con tasselli adeguati al supporto  
prestare attenzione a non danneggiare il LED con il cacciavite  
2) attach the base to the wall with adequate support anchors  
be careful not to damage the LED with the screwdriver

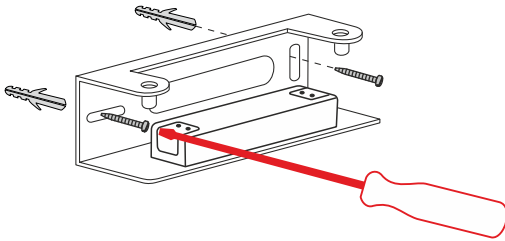

- 3) Effettuare il collegamento elettrico  
3) Make the electrical connection

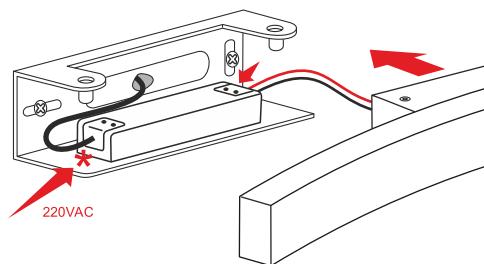

- 4) Chiudere l'apparecchio tramite le apposite viti  
4) Close the device using the screws

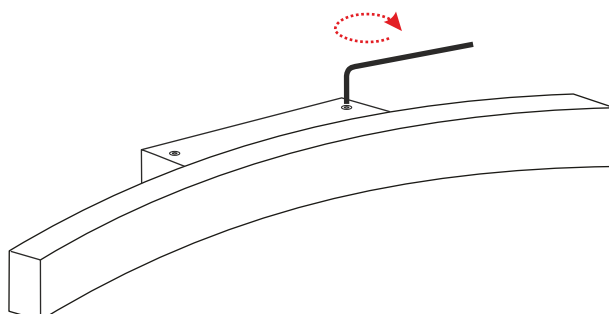

PRODOTTO / PRODUCT

BELLAI HOME

MONTAGGIO / MOUNTING

Parete/Wall

CODICI / CODES

2027AOF  
2027ADM  
2027BOF  
2017BDM

n°INSTALLATORI / n° INSTALLER



STRUMENTI / INSTRUMENTS

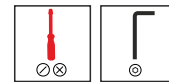

TEMPO / TIME



CERTIFICAZIONI / CERTIFICATIONS



ATTENZIONE / CAUTION



Togliere la rete di alimentazione prima dell'installazione, sostituzione della lampada e comunque prima di ogni operazione di manutenzione.

**Always turn off power supply before install, replacing of the light bulb and prior to any maintenance interventions.**



La sicurezza dell'apparecchio è garantita solo con l'uso appropriato delle seguenti istruzioni; pertanto è necessario consultarle attentamente e conservarle.

**The safety of this product is guaranteed only if correctly used, according to this instruction sheet, which must be read first**

†

## COLLEGAMENTO ELETTRICO \* ELECTRICAL CONNECTION



Attenzione! Togliere la rete di alimentazione prima dell'installazione, sostituzione della lampada e comunque prima di ogni operazione di manutenzione.

**Caution!** Always turn off power supply before install, replacing of the light bulb and prior to any maintenance interventions.

### Versione ONOFF ONOFF Version

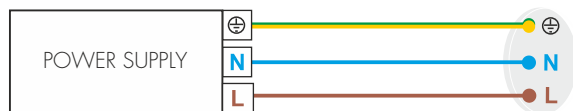

### Versione dimmerabile - Collegamento con pulsante Dimmable Version - Touch-DIM wiring

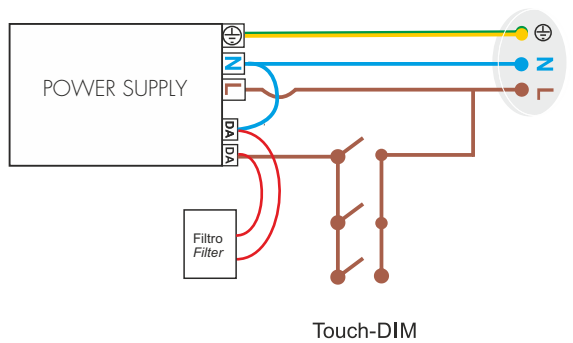

### Versione dimmerabile - Collegamento con sistema di gestione Dimmable Version - Management System wiring

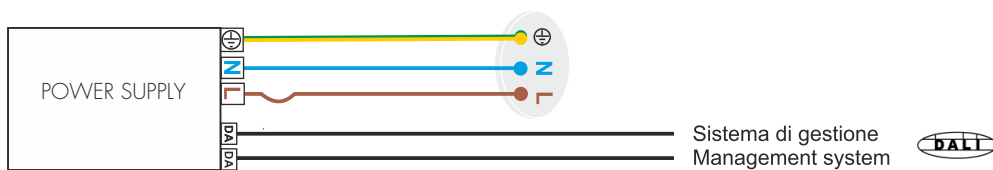

### Versione TAGLIO DI FASE

